

**FLUKE**®

**Biomedical**

# ProSim™ 4

Vital Signs Simulator

**Getting Started**

PN 3931478

January 2011, Rev. 3, 2/15

© 2011-2015 Fluke Corporation. All rights reserved. Specifications are subject to change without notice.  
All product names are trademarks of their respective companies.

## **Warranty and Product Support**

Fluke Biomedical warrants this instrument against defects in materials and workmanship for one year from the date of original purchase OR two years if at the end of your first year you send the instrument to a Fluke Biomedical service center for calibration. You will be charged our customary fee for such calibration. During the warranty period, we will repair or at our option replace, at no charge, a product that proves to be defective, provided you return the product, shipping prepaid, to Fluke Biomedical. This warranty covers the original purchaser only and is not transferable. The warranty does not apply if the product has been damaged by accident or misuse or has been serviced or modified by anyone other than an authorized Fluke Biomedical service facility. NO OTHER WARRANTIES, SUCH AS FITNESS FOR A PARTICULAR PURPOSE, ARE EXPRESSED OR IMPLIED. FLUKE SHALL NOT BE LIABLE FOR ANY SPECIAL, INDIRECT, INCIDENTAL OR CONSEQUENTIAL DAMAGES OR LOSSES, INCLUDING LOSS OF DATA, ARISING FROM ANY CAUSE OR THEORY.

This warranty covers only serialized products and their accessory items that bear a distinct serial number tag. Recalibration of instruments is not covered under the warranty.

This warranty gives you specific legal rights and you may also have other rights that vary in different jurisdictions. Since some jurisdictions do not allow the exclusion or limitation of an implied warranty or of incidental or consequential damages, this limitation of liability may not apply to you. If any provision of this warranty is held invalid or unenforceable by a court or other decision-maker of competent jurisdiction, such holding will not affect the validity or enforceability of any other provision.

7/07

## Notices

---

### All Rights Reserved

© Copyright 2015, Fluke Biomedical. No part of this publication may be reproduced, transmitted, transcribed, stored in a retrieval system, or translated into any language without the written permission of Fluke Biomedical.

---

### Copyright Release

Fluke Biomedical agrees to a limited copyright release that allows you to reproduce manuals and other printed materials for use in service training programs and other technical publications. If you would like other reproductions or distributions, submit a written request to Fluke Biomedical.

---

### Unpacking and Inspection

Follow standard receiving practices upon receipt of the instrument. Check the shipping carton for damage. If damage is found, stop unpacking the instrument. Notify the carrier and ask for an agent to be present while the instrument is unpacked. There are no special unpacking instructions, but be careful not to damage the instrument when unpacking it. Inspect the instrument for physical damage such as bent or broken parts, dents, or scratches.

---

### Technical Support

For application support or answers to technical questions, either email [techservices@flukebiomedical.com](mailto:techservices@flukebiomedical.com) or call 1-800-850-4608 or 1-440-248-9300. In Europe, email [techsupport.emea@flukebiomedical.com](mailto:techsupport.emea@flukebiomedical.com) or call +31-40-2965314.

---

### Claims

Our routine method of shipment is via common carrier, FOB origin. Upon delivery, if physical damage is found, retain all packing materials in their original condition and contact the carrier immediately to file a claim. If the instrument is delivered in good physical condition but does not operate within specifications, or if there are any other problems not caused by shipping damage, please contact Fluke Biomedical or your local sales representative.

---

## Returns and Repairs

### Return Procedure

All items being returned (including all warranty-claim shipments) must be sent freight-prepaid to our factory location. When you return an instrument to Fluke Biomedical, we recommend using United Parcel Service, Federal Express, or Air Parcel Post. We also recommend that you insure your shipment for its actual replacement cost. Fluke Biomedical will not be responsible for lost shipments or instruments that are received in damaged condition due to improper packaging or handling.

Use the original carton and packaging material for shipment. If they are not available, we recommend the following guide for repackaging:

- Use a double-walled carton of sufficient strength for the weight being shipped.
- Use heavy paper or cardboard to protect all instrument surfaces. Use nonabrasive material around all projecting parts.
- Use at least four inches of tightly packed, industry-approved, shock-absorbent material around the instrument.

### Returns for partial refund/credit:

Every product returned for refund/credit must be accompanied by a Return Material Authorization (RMA) number, obtained from our Order Entry Group at 1-440-498-2560.

### Repair and calibration:

To find the nearest service center, go to [www.flukebiomedical.com/service](http://www.flukebiomedical.com/service) or

#### In the U.S.A.:

Cleveland Calibration Lab  
Tel: 1-800-850-4608 x2564  
Email: [globalcal@flukebiomedical.com](mailto:globalcal@flukebiomedical.com)

Everett Calibration Lab  
Tel: 1-888-99 FLUKE (1-888-993-5853)  
Email: [service.status@fluke.com](mailto:service.status@fluke.com)

#### In Europe, Middle East, and Africa:

Eindhoven Calibration Lab  
Tel: +31-40-2675300  
Email: [ServiceDesk@fluke.com](mailto:ServiceDesk@fluke.com)

#### In Asia:

Everett Calibration Lab  
Tel: +425-446-6945  
Email: [service.international@fluke.com](mailto:service.international@fluke.com)

To ensure the accuracy of the Product is maintained at a high level, Fluke Biomedical recommends the product be calibrated at least once every 12 months. Calibration must be done by qualified personnel. Contact your local Fluke Biomedical representative for calibration.

---

## Certification

This instrument was thoroughly tested and inspected. It was found to meet Fluke Biomedical's manufacturing specifications when it was shipped from the factory. Calibration measurements are traceable to the National Institute of Standards and Technology (NIST). Devices for which there are no NIST calibration standards are measured against in-house performance standards using accepted test procedures.

---

## WARNING

Unauthorized user modifications or application beyond the published specifications may result in electrical shock hazards or improper operation. Fluke Biomedical will not be responsible for any injuries sustained due to unauthorized equipment modifications.

---

## Restrictions and Liabilities

Information in this document is subject to change and does not represent a commitment by Fluke Biomedical. Changes made to the information in this document will be incorporated in new editions of the publication. No responsibility is assumed by Fluke Biomedical for the use or reliability of software or equipment that is not supplied by Fluke Biomedical, or by its affiliated dealers.

---

## Manufacturing Location

The ProSim™ 4 is manufactured at Fluke Biomedical, 6920 Seaway Blvd., Everett, WA, U.S.A.



# Table of Contents

Title	Page
Introduction .....	1
Intended Use .....	1
Safety Information .....	2
Symbols .....	3
Unpack the Product.....	3
Accessories.....	4
Instrument Familiarization .....	6
How to Turn On the Product.....	10
How to Change the Display Language .....	10
Maintenance.....	11
How to Clean the Product.....	12
Battery Maintenance.....	13
How to Charge the Battery .....	13
Battery Removal .....	15
General Specifications .....	16

Detailed Specifications .....	17
Normal-Sinus-Rhythm Waveform .....	17
Arrhythmia .....	17
ECG-Performance-Testing .....	18
Respiration.....	18
Invasive Blood Pressure .....	19
Non-Invasive Blood Pressure.....	19
Presets and Autosequences .....	20



# ***List of Tables***

<b>Table</b>	<b>Title</b>	<b>Page</b>
1.	Simulation Types.....	1
2.	Symbols.....	3
3.	Standard Accessories .....	4
4.	Optional Accessories.....	5
5.	Product Controls and Connections.....	7
6.	Display Features .....	9



# *List of Figures*

<b>Figure</b>	<b>Title</b>	<b>Page</b>
1.	Product Controls and Connections .....	6
2.	Display Features .....	8
3.	Home Screen .....	10
4.	External Battery Charging Connection .....	14
5.	Battery Removal .....	15



## **Introduction**

The ProSim™ 4 Vital Signs Simulator (the Product) is a portable vital signs monitor functional tester.

The product simulates:

- ECG Functions
- Respiration
- Invasive and non-invasive Blood Pressure

When the term simulation is used in connection with ECG, respiration, IBP, or NIBP, the simulation type shown in Table 1 is used in this Product.

**Table 1. Simulation Types**

<b>Parameter</b>	<b>Simulation Type</b>
ECG	Electrical
Respiration	Electrical
IBP	Electrical
NIBP	Pneumatic

## **Intended Use**

The Product is intended to be used to test and verify the basic operation of patient monitoring devices or systems used to monitor various physiological parameters of a patient, including ECG, respiration, invasive blood pressure, and non-invasive blood pressure.

The intended user is a trained biomedical equipment technician who performs periodic preventative maintenance checks on patient monitors in service. Users can be associated with Hospitals, clinics, original equipment manufacturers and independent service companies that repair and service medical equipment. The end user is an individual, trained in medical instrumentation technology.

This Product is intended to be used in the laboratory environment and is not intended for use on patients, or to test devices while connected to patients. This Product is not intended to be used to calibrate medical equipment. It is intended for over the counter use.

## **Safety Information**

In this manual, a **Warning** identifies hazardous conditions and actions that could cause bodily harm or death. A **Caution** identifies conditions and actions that could damage the Analyzer, the equipment under test, or cause permanent loss of data.

### **Warnings**

**To prevent personal injury, use the Product only as specified, or the protection supplied by the Product can be compromised.**

**To prevent possible electrical shock, fire, or personal injury:**









- **Do not use and disable the Product if it is damaged.**
- **The battery door must be closed and locked before you operate the Product.**
- **Remove all probes, test leads, and accessories that are not necessary for the measurement.**
- **Do not use the Product around explosive gas, vapor, or in damp or wet environments.**

- **Do not use the Product if it operates incorrectly.**
- **Do not connect the Product to a patient or equipment connected to a patient. The Product is intended for equipment evaluation only and should never be used in diagnostics, treatment, or any other capacity where the Product would come in contact with a patient.**
- **Read all safety Information before you use the Product.**
- **Examine the case before you use the Product. Look for cracks or missing plastic. Carefully look at the insulation around the terminals.**
- **Carefully read all instructions.**

## Symbols

Table 2 is a list of symbols found in this manual or on this Product.

**Table 2. Symbols**

Symbol	Description	Symbol	Description
	Risk of danger. Important information. See manual.		Hazardous voltage. Risk of electric shock.
	Conforms to European Union directives.		Input jack for the dc output of the ac/dc supply connector.
	Conforms to relevant Australian EMC standards		Conforms to relevant North American safety standards
	Spent Lithium batteries should be disposed of by a qualified recycler or hazardous materials handler per local regulations. Contact your authorized Fluke Service Center for recycling information.		
	This product complies with the WEEE Directive (2002/96/EC) marking requirements. The affixed label indicates that you must not discard this electrical/electronic product in domestic household waste. Product Category: With reference to the equipment types in the WEEE Directive Annex I, this product is classed as category 9 "Monitoring and Control Instrumentation" product. Do not dispose of this product as unsorted municipal waste. Go to Fluke's website for recycling information.		

## Unpack the Product

Carefully unpack all items from the box and check that you have these items:

- ProSim™ 4
- Getting Started Manual
- Users Manual CD
- Carrying Case
- Power Cord
- AC/DC Power Supply
- Manual Inflation Bulb
- NIBP Cuff Adapters

**Accessories**

Available Product accessories are shown in Tables 3 and 4.

**Table 3. Standard Accessories**

Item		Fluke Biomedical Part Number
ProSim™ 4 Getting Started Manual		3931478
ProSim™ 4 Users Manual CD		3931519
AC/DC Power Supply		3978380
AC Power Cord	US	284174
	Schuko	769422
	UK	769455
	Japan	284174
	Australia	658641
	Brazil <sup>[1]</sup>	3841347
Manual inflation bulb		2461946
Set of NIBP Cuff Adapters		2391882
Carrying Case		4026799
[1] Product shipped to Brazil also includes a US power cord.		

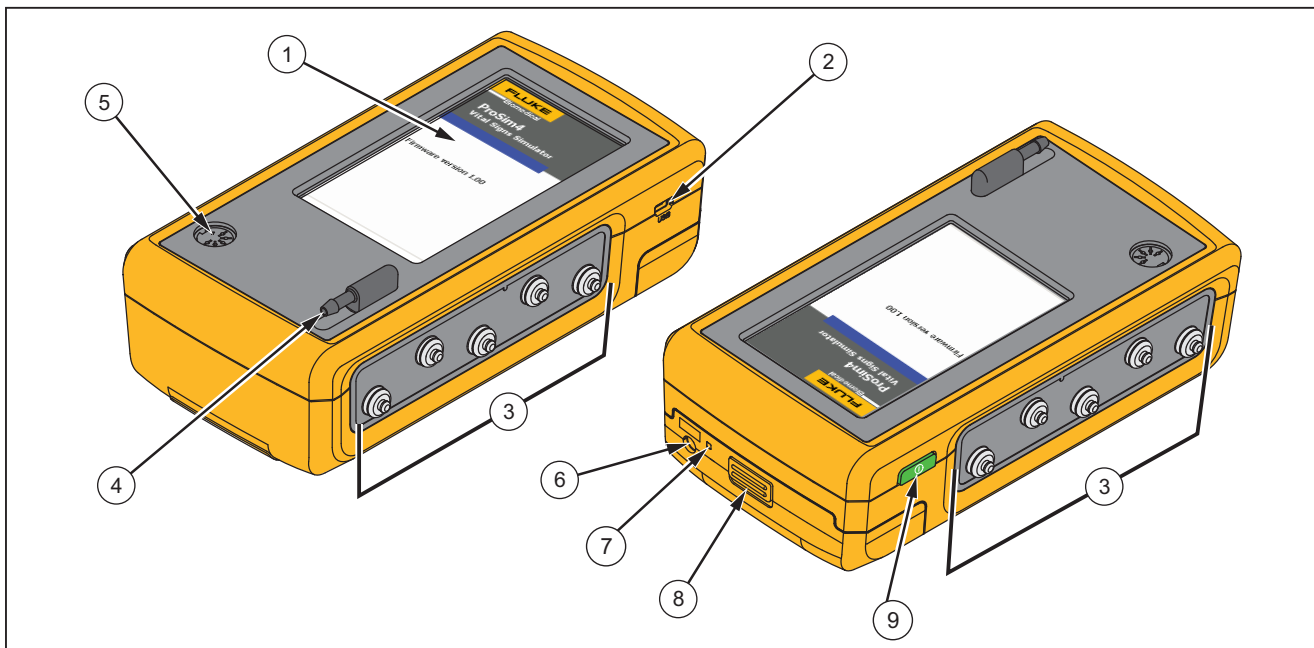

**Table 4. Optional Accessories**

<b>Item</b>	<b>Fluke Biomedical Part Number</b>
Battery pack	4026823
USB Cable, Mini Series B, 1 meter long	4034393
NIBP Mandrel Set	4308086
Modules to convert ECG snap adapter to 4 mm and 3.2 mm ECG banana adapter as part of optional accessories – For International use only	4026551
IBP Cables	See your Fluke Biomedical Distributor

## Instrument Familiarization

Table 5 is a list of Product controls and connections shown in Figure 1.



**Figure 1. Product Controls and Connections**

gne019.eps

**Table 5. Product Controls and Connections**

<b>Item</b>	<b>Name</b>	<b>Description</b>
①	LCD Display	Color LCD touch-sensitive display
②	Mini-Series B Connector	For firmware updates and calibration.
③	ECG Posts	Connection posts for Device Under Test (DUT) ECG leads.
④	Air Port Connector	Pressure port for NIBP cuff and monitor.
⑤	IBP Channel 1 Connector	Connector to an IBP input of the patient monitor.
⑥	DC Power Connector	Connector for the AC/DC power supply.
⑦	Battery LED	Indicates when the battery is charged.
⑧	Battery Latch	Locks battery in the Product
⑨	Power Button	Turns on and off the Product.

Figure 2 and Table 6 identify the display features.

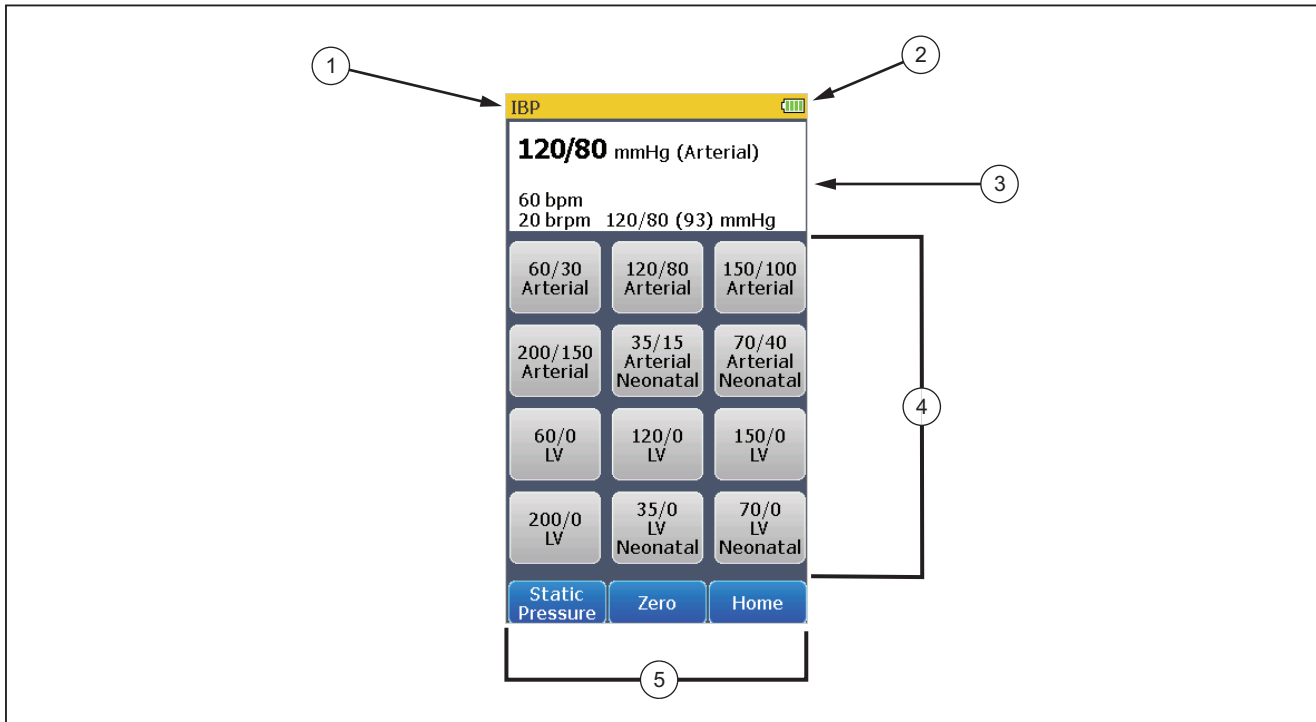



gne010.eps

**Figure 2. Display Features**

**Table 6. Display Features**

<b>Item</b>	<b>Name</b>	<b>Description</b>
①	Name	Screen name
②	Battery	ICON that indicates the charge level of the battery.
③	Simulation parameters	Shows the simulation parameter values
④	Controls	Touch sensitive controls to set simulation parameters and Product features.
⑤	Softkeys	Three touch sensitive controls that activate the function shown inside the control.

## **How to Turn On the Product**

Push  on the left side panel to turn on the Product.  
Push  for three seconds to turn off the Product.

When the self test is complete and no errors are sensed, the Home screen in Figure 3 shows in the display.

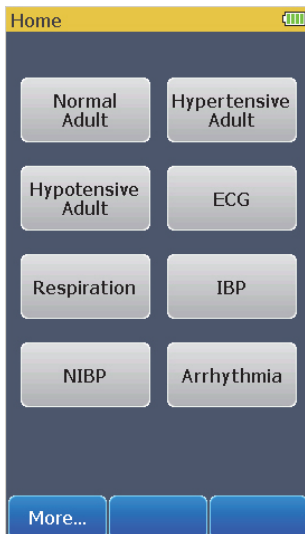



**Figure 3. Home Screen**

All Product simulations and tests are set through the controls on the Home screen.

## **How to Change the Display Language**

To change the language used in the display:

1. From the home screen shown in Figure 3, touch the **More** softkey.
2. Touch the **Setup** control.
3. Touch the **Language** control.
4. Touch  or  to scroll through the languages.
5. Touch the **Save** softkey to set the language and go back to the Setup screen.

Touch the **Cancel** softkey to go back to the Setup screen and not change the language.

gne102.jpg

## **Maintenance**

The Product is a calibrated measurement instrument. Try to prevent mechanical abuse that could change the calibrated values. The Product has no internal user-serviceable parts.

### Warnings

**For safe operation and maintenance of the Product:**

- **Do not keep cells or batteries in a container where the terminals can be shorted.**
- **Connect the battery charger to the mains power outlet before the Product.**
- **Repair the Product before use if the battery leaks.**
- **Remove batteries to prevent battery leakage and damage to the Product if it is not used for an extended period.**
- **Do not short the battery terminals together.**
- **Keep cells and battery packs clean and dry. Clean dirty connectors with a dry, clean cloth.**
- **Use only Fluke Biomedical approved power adapters to charge the battery.**

To prevent personal injury:

- Do not disassemble the battery.
- Batteries contain hazardous chemicals that can cause burns or explode. If exposure to chemicals occurs, clean with water and get medical aid.
- Do not put battery cells and battery packs near heat or fire. Do not put in sunlight.
- Do not disassemble or crush battery cells and battery packs.

To prevent possible electrical shock, fire, or personal injury:

- Remove the input signals before you clean the Product.
- Use only specified replacement parts.
- Have an approved technician repair the Product.

### **How to Clean the Product**

#### **⚠ Caution**

**Do not pour fluid onto the Product surface; fluid seepage into the electrical circuitry may cause the Product to fail.**

**Do not use spray cleaners on the Product; such action may force the cleaning fluid into the Product and damage electronic components.**

Clean the Analyzer occasionally with a damp cloth and mild detergent. Try to prevent the entrance of liquids.

Clean the adapter cables with the same precautions. Examine them for damage and deterioration of the insulation. Examine the connections for integrity. Keep the transducer adapter clean and dry.



## Battery Maintenance

For peak battery performance, charge the Product to maximum charge once a month. If the Product is not to be used for more than a month, keep it connected to the charger.

### Note

*To get the specified performance, use the specified battery charger that comes with this Product.*

When the battery gets low a low battery message shows in the display.

When the battery discharges to a low level threshold, a warning shows in the display to indicate the NIBP function is disabled.

## How to Charge the Battery

The battery charge level is shown in the upper right corner of the display.



Shows when the ac/dc power supply is connected



Shows the battery level when the Product operates on the battery

The battery can be charged while it is in or out of the Product. The charge rate is slower when the Product is energized and the battery charger is on. To charge the battery:

1. As shown in Figure 4, connect the ac/dc power supply to the power connector on the battery pack.
2. Connect the ac/dc power supply to a power source.

The battery charge LED on the battery pack shows red or green when the ac/dc power supply is connected to the battery pack. When the LED is green, the battery is charged.

When you have two or more battery packs, you can charge one battery externally while you use the other to energize the Product.

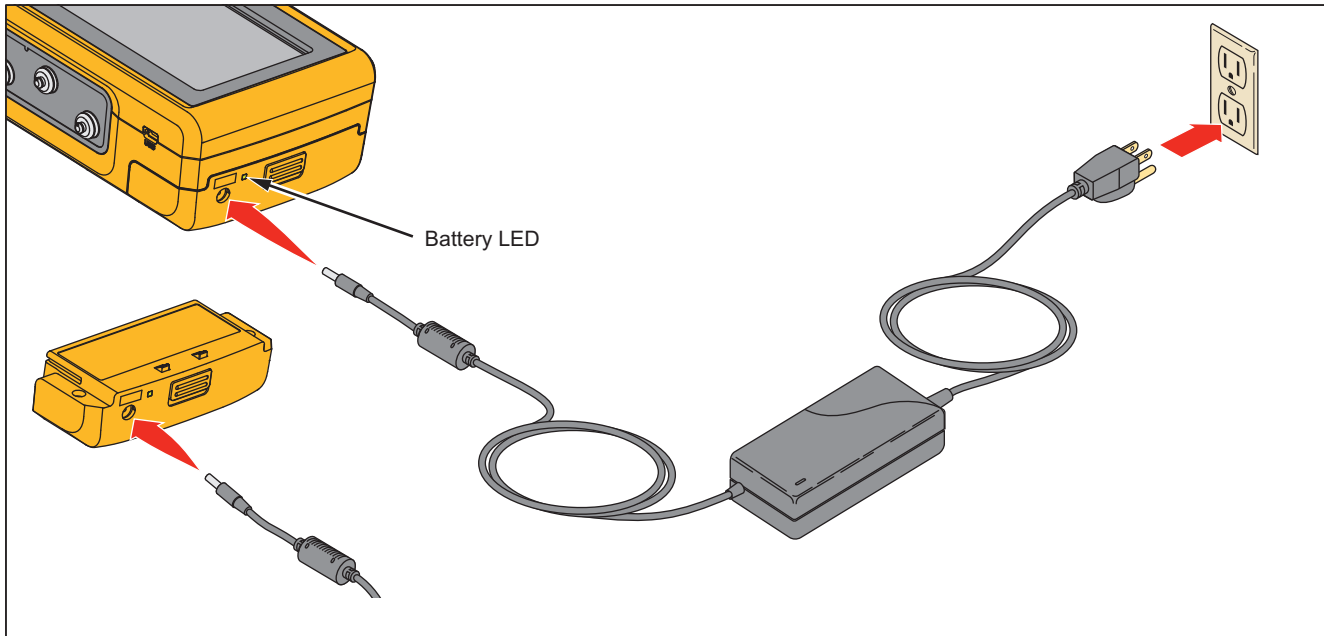

gne022.eps

**Figure 4. External Battery Charging Connection**

### **Battery Removal**

The battery pack is easy to remove and replace. To remove the battery pack:

1. Push down on the battery pack latch as shown in Figure 5.

2. Pull the battery pack from the Product.

To put the battery pack into the Product, align the battery pack with the guides on the Product and push it into the Product until the catch locks.

The ProSim 4 battery is not compatible with the ProSim 6/8.

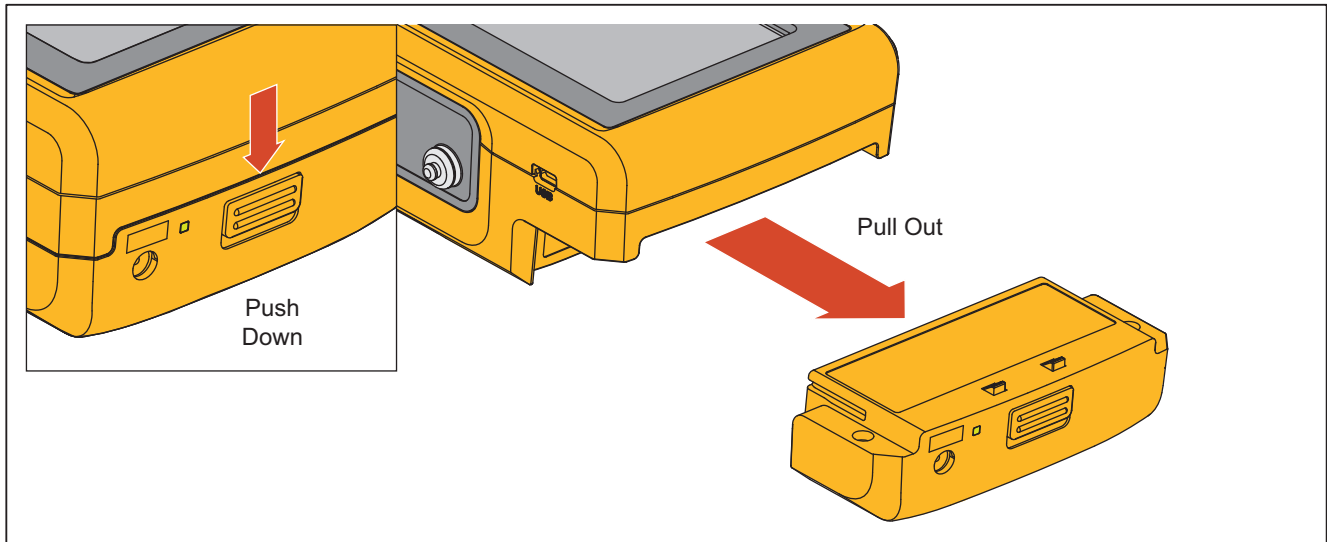

gne023.eps

**Figure 5. Battery Removal**

## **General Specifications**

### **Temperature**

Operating .....	10 °C to 40 °C (50 °F to 104 °F)
Storage .....	-20 °C to +60 °C (-4 °F to +140 °F)

**Humidity** ..... 10 % to 90 % non-condensing

**Altitude** ..... 3,000 meters (9,843 ft)

**Size (L x W x H)** ..... 18.0 cm x 9.3 cm x 5.5 cm (7.1 in x 3.7 in x 2.2 in)

**Display** ..... LCD Touch-Screen Color Display

**Communication** ..... USB Port (for calibration and firmware updates only)

**Power** ..... Lithium-Ion rechargeable battery, 10.75 Wh, 3.7 V, 2900 mAh

**Battery Charger** ..... 110 to 220 Vac, 50/60 Hz input, 6 V/3.5 A output. For best performance, the battery charger should be connected to a properly grounded ac receptacle.

**Battery Life** ..... 4 hours (minimum), 40 NIBP cycles typical

**Weight** ..... 0.88 kg (1.93 lb)

**Safety** ..... IEC 61010-1: Category II, Pollution Degree 2

### **Electromagnetic Compatibility (EMC)**

International .....	IEC 61326-1: Basic Electromagnetic Environment CISPR 11: Group 1, Class A
---------------------	--

*Group 1: Equipment has intentionally generated and/or uses conductively-coupled radio frequency energy that is necessary for the internal function of the equipment itself.*

*Class A: Equipment is suitable for use in all establishments other than domestic and those directly connected to a low-voltage power supply network that supplies buildings used for domestic purposes. There may be potential difficulties in ensuring electromagnetic compatibility in other environments due to conducted and radiated disturbances.*

*Emissions that exceed the levels required by CISPR 11 can occur when the equipment is connected to a test object.*

USA (FCC).....	47 CFR 15 subpart B
----------------	---------------------

## **Detailed Specifications**

### **Normal-Sinus-Rhythm Waveform**

<b>ECG Reference</b> .....	The ECG amplitudes specified are for Lead II (calibration), from the baseline to the peak of the R wave. All other leads are proportional.
<b>Normal Sinus Rhythm</b> .....	12-lead configuration with independent outputs referenced to right leg (RL). Output to 10 Universal ECG Jacks, color-coded to AHA and IEC Standards.
<b>Amplitude</b> .....	1.0 mV. Other leads are proportional to Lead II (reference lead) in percentage per:
Lead I .....	70
Lead II .....	100
Lead III .....	30
Lead V1 .....	24
Lead V2 .....	48
Lead V3 .....	100
Lead V4 .....	120
Lead V5 .....	112
Lead V6 .....	80
<b>Amplitude Accuracy</b> .....	±5 % of setting Lead II
<b>ECG Rate</b> .....	30, 60, 80, 90, 120, 150, 180, 210, 240, 270, 300, and 320 BPM (Preset Hypotensive condition is at 40 BPM)
<b>Rate Accuracy</b> .....	±1 % of setting
<b>ECG Waveform Selection</b> .....	Adult (80 ms) or neonatal (40 ms) QRS duration
<b>Power-On Default</b> .....	60 BPM, 1.0 mV, adult QRS

### **Arrhythmia**

<b>Atrial Fibrillation</b> .....	Coarse or fine
<b>Premature Ventricular Contraction</b> .....	Left Ventricular
<b>Ventricular Tachycardia</b> .....	160 or 200 BPM

**Ventricular Fibrillation** ..... Coarse or fine  
**Transvenous Pacer Pulse** ..... 75 BPM, left arterial, 3 mV amplitude on lead II, Accuracy  $\pm 10\%$ , 1.0 ms width  
**2nd Degree AV Block** ..... Type 1  
**3rd Degree AV Block**

**Asystole**

### **ECG-Performance-Testing**

**Amplitude** ..... 1 mV. Other leads are proportional to Lead II (reference lead) in percentage per:

Lead I ..... 70  
Lead II ..... 100  
Lead III ..... 30  
Lead V1 ..... 24  
Lead V2 ..... 48  
Lead V3 ..... 100  
Lead V4 ..... 120  
Lead V5 ..... 112  
Lead V6 ..... 80

**Square Wave** ..... 60 ms at 2.0 Hz

### **Respiration**

**Rate** ..... 0 (OFF), 10 to 100 BrPM in 10 BrPM steps

**Impedance Variations ( $\Delta \Omega$ )** ..... 1  $\Omega$

**Accuracy Delta** .....  $\pm(10\% + 0.05 \text{ ohm})$

**Baseline** ..... 500  $\Omega$  to circuit common, giving 1000  $\Omega$  between any two leads

**Accuracy Baseline** .....  $\pm 5\%$

**Respiration Lead** ..... LA or LL (default)

**Invasive Blood Pressure**

- Channels** ..... 1 electrically isolated from all other signals
- BP Output**.....Circular DIN 5-Pin
- Input/output Impedance**.....300  $\Omega$   $\pm$ 10 %
- Exciter Input Range**.....2.0 to 16.0 V peak
- Exciter-Input Frequency Range** .....DC to 5000 Hz
- Transducer Sensitivity**.....5  $\mu$ V/V/mmHg
- Pressure Accuracy**..... $\pm$ (1 % of setting + 1 mmHg) Accuracy guaranteed for DC excitation only
- Static Pressure** .....0, 80, 160, and 250 mmHg
- Dynamic Waveforms**
  - Synchronization..... To ECG heartrate
  - Chambers simulated systolic/diastolic pressure:

Type	IBP (Arterial)	IBP (Left Ventrical)
Adult	60/30	60/0
Adult	120/80	120/0
Adult	150/100	150/0
Adult	200/150	200/0
Neonatal	35/15	35/0
Neonatal	70/40	70/0

**Non-Invasive Blood Pressure**

- Pressure Units** ..... mmHg
- Manometer (Pressure Meter)**
  - Range.....10 to 400 mmHg
  - Resolution .....0.1 mmHg (for display purposes)
  - Accuracy..... $\pm$ (1 % reading +1 mmHg)
- Pressure Source**.....Inflation bulb or device under test

**NIBP Simulations**

Pulse .....	2 mmHg max into 500 ml NIBP system
Volume of air moved .....	1.0 ml max
Simulations .....	Systolic/diastolic (MAP)
Adult .....	60/30 (40), 120/80 (93); 150/100 (117); and 200/150 (167)
Neonatal .....	35/15 (22) and 70/40 (50)
Repeatability .....	Within $\pm 2$ mmHg (at maximal pulse size independent of device under test)
Synchronization .....	To ECG heartrate (maximal rate 120 BPM)

**Leak Test**

Target Pressure .....	20 to 400 mmHg
Elapse time .....	0:30 to 5:00 minutes:seconds in 30 second steps
Leakage Rate .....	0 to 200 mmHg/minute
Internal Leak rate .....	<2 mmHg/min into 500 ml rigid volume

**Pressure Relief Test Range** ..... 100 to 400 mmHg

***Presets and Autosequences***

Presets

- Normal
- Hypertensive
- Hypotensive

Autosequences

- Cardiac Failure sequence
- Exercise sequence
- Respiration sequence
- Monitor testing sequence